

RJ11 6P4C Side Entry Connector:

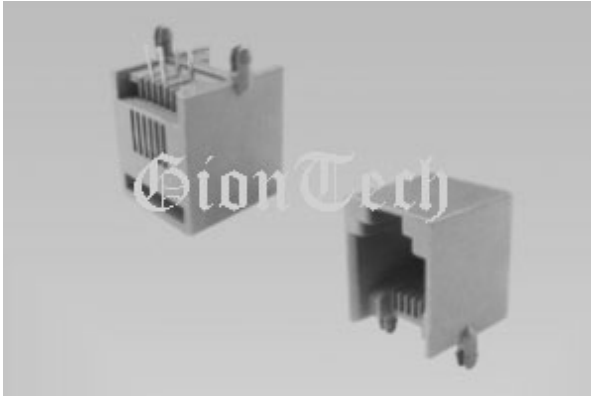

SPECIFICATIONS

Power Rating:	1.5A/125V AC, DC.
Operating Temperature:	-40°C ~+105°C
Relative Humidity:	93%, +40°C
Dielectric Withstanding:	1000V AC/minute
Contact Resistance:	≤ 20 mΩ/Contact
Insulator Resistance:	≥ 500 MΩ at 500V
Material:	
Base:	PBT/Nylon6T, UL94V-0
Contact Pin:	Copper Alloy
Contact Plating:	Au Over 50u" Ni

ROHS Compliance

RJ11-6P4C-11X

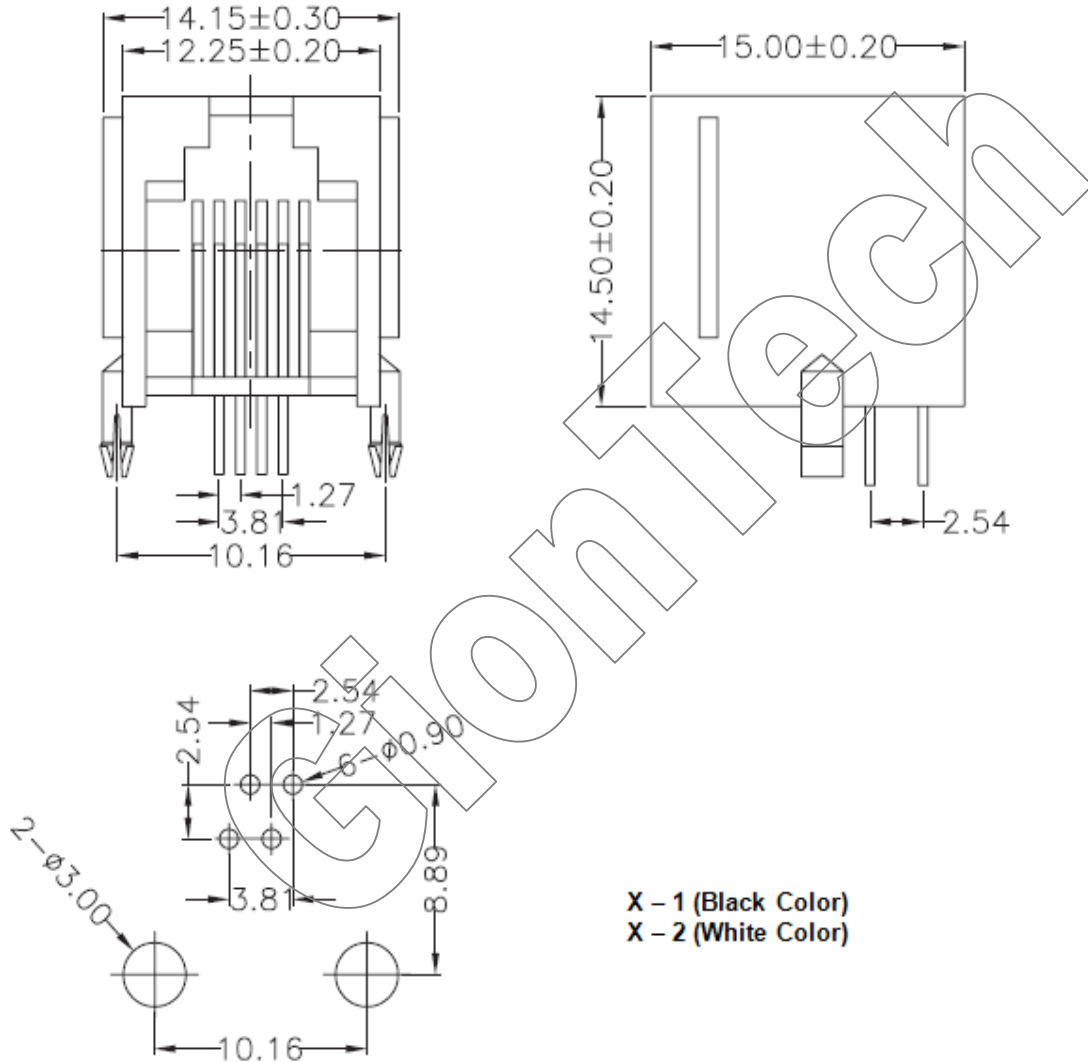

X - 1 (Black Color)
X - 2 (White Color)

Recommended PCB layout